

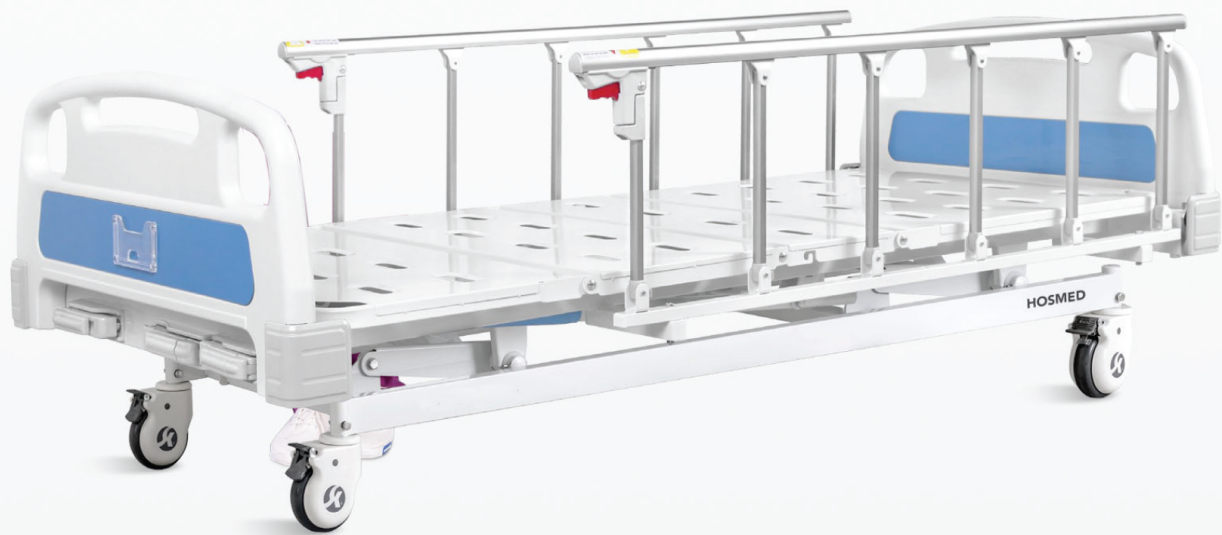

NIAGARA Series

3 Position Manual Bed
NB3M



Features



Steels | Painting

Baosteel from Fortune Global 500 11 Process epoxy painting, ASTM testing anti-bacterial, paint thickness 0.12 mm, brightness 60°, paint can resist 50kg impact



Plastic

Environmental plastic can be sterilized in 100°C, tensile upto 30MPa Virgin ABS material



Bumper Cover

Reduce the impact of the collision, safe and slinky.



Hand Control

Retractable hand crank, 100,000 times remaining intact
Extreme protection device, sounds when tipped to the max position, Strong pallets to increase the bed height adjustment(400-710mm)a



Design

Morden design. Use new and strong inserted ABS fire-proof panel avoid off. Easy to be cleaned and installed. Net weight over 3.6kg.

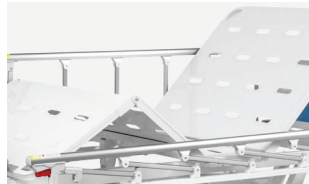

Platform

Stamping forming platform, smooth surface no welding scar, bearing 135KG load. Option resin X-ray translucent platform.

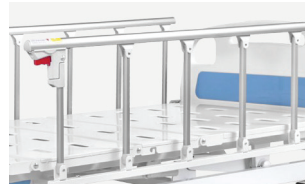

Siderail

Aluminum alloy side rail, 6-staff, collapsed type with safe lock.



Castors

5" covered casters TPR tire no worn out after running 30KM, save anti-winding hard shell, united forming without bolts. Pass Dynamic test: Bearing 120kg run 30KM and pass obstacles 500 time.

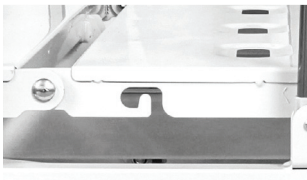

Drainage Hooks

Laser cutting drainage hook, both sides.



IV Pole

Full SS IV pole, bearing 15kg.

Technical Chart

Technical parameters

External size (LxWxH)	2110x960x400-710 mm
Mattress platform	1925x820 mm
Safe working load	135 kg
Back-rest adjustment	0-75° (±10°)
Knee-rest adjustment	0-35° (±10°)



Technical configuration

Manual Cranks	3pcs
5" Covered Castors	4pcs
Foldable Side Rail	1set
ABS Bed ends with Safe lock	1set
IV Pole	1set
IV Pole Prevision	4pcs
Drainage Hook	4pcs
Mattress Holder	2pcs

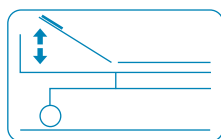
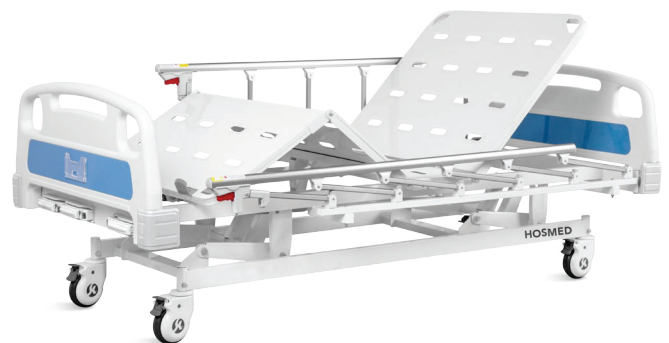

Back-rest
adjustment

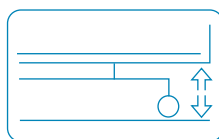

Height
adjustment

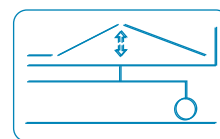

Knee-rest
adjustment



3403 NW 82nd Avenue, Suite 102 E.
Doral, Florida 33122. USA
www.hosmed-inc.com